







28 679 670



- Ausladung 450 mm
- Regenbrause Ø 300 mm
- PURE RAIN, Durchfluss max. 14 l/min (bei 3 Bar)
- Funktion ab: 10 l/min
- Rosette 65 x 65 mm
- Anschluss 1/2"
- mit Antikalk-System
- mit Leerlauf-Funktion

	Platin	28 679 670-08
	Chrom	28 679 670-00
	Platin gebürstet	28 679 670-06
	Messing gebürstet (23kt Gold)	28 679 670-28
	Schwarz matt	28 679 670-33
	Chrom gebürstet	28 679 670-93
	Dark Platin gebürstet	28 679 670-99

Empfohlenes Zubehör



- UP-Wandwinkel -** 35 085 970 90
- Max. Einbautiefe 163 mm
 - Min. Einbautiefe 90 mm

28 679 670

mm [inches]

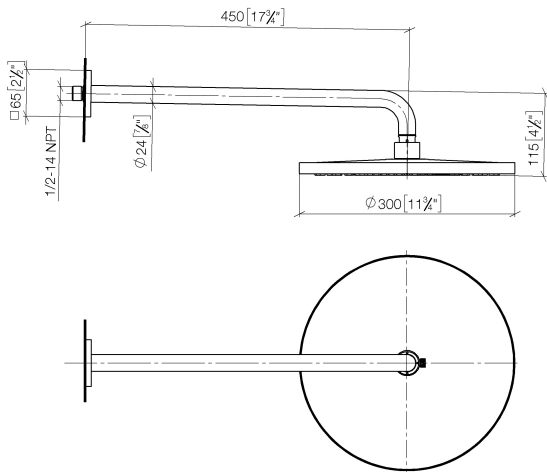

Durchflussdiagramm

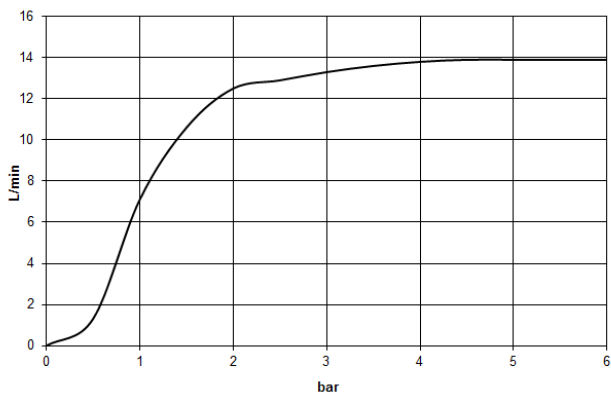

Zertifikate

WRAS_2212012. LGA_29235.

28 679 670

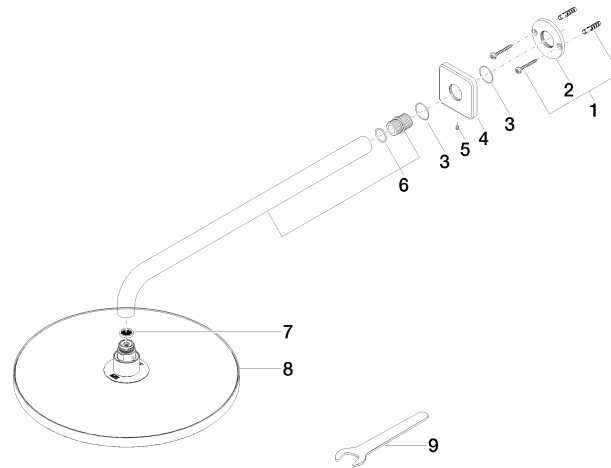

Ersatzteilstückliste

Nr.	Artikelnummer	Benennung	Verbaumenge	Lieferzeit
1	04 30 31 032 00 90	Befestigungssatz	1	2
2	09 17 20 120 90	Halter	1	2
3	09 14 10 150 90	Dichtung	2	2
4	09 27 67 015-08	Rosette	1	40
5	90 31 11 038 00 90	Stift	1	2
6	90 11 03 070 00-08	Rohr	1	40
7	09 23 01 075 90	Einsatz	1	2
8	04 12 05 091 00-08	Brause	1	40
9	90 30 09 069 00 90	Schlüssel	1	2